

PLATLINE™

ZINC RIBBON ANODES FOR AC MITIGATION

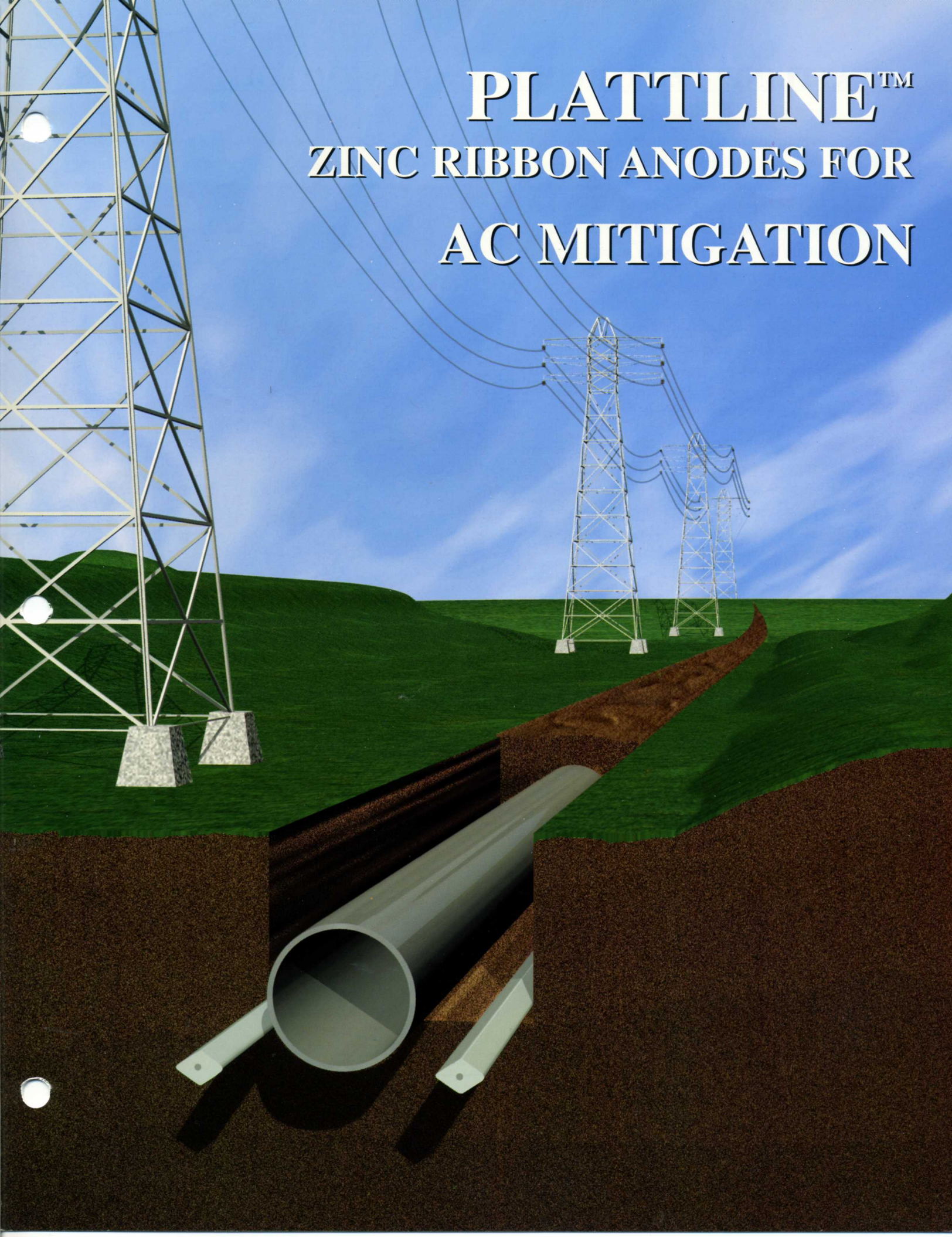

PLATLINE™ ZINC RIBBON ANODES

The long-term trend in the United States and many other countries is shared land use for pipelines and other utilities. This movement has increased the number of overhead high voltage transmission lines parallel to and sharing a corridor with an underground pipeline. This combination has increased the need for grounding of the pipeline to dissipate interference.

In these systems, A.C. voltages are transmitted to the pipeline by conductive or inductive interference. Magnetic induction acts along the pipeline or pipeline segment that is approximately parallel to the power line and can cause significant pipeline potentials even at relatively large separation distances.

Consideration must be given to safety of personnel and the public who may come into contact with above ground portions of the pipeline such as valves and test stations. These exposed structures can be a potential shock hazard when touched while the soil is at a significantly different potential.

Advances in interference control have resulted in the gradient control wire method. This method consists of one or more bare zinc conductors buried parallel to and near the pipeline and regularly connected to it. Plattline™ zinc ribbon anode used in this way is very effective in mitigating excessive pipeline potentials due to both inductive and conductive interference. (See Figures 1 & 2.) Plattline evens out pipeline and soil potential differences. Additionally, Plattline can provide cathodic protection to the pipeline.

It is important to review the use and design of a gradient control wire system with an engineer experienced with this system, as its performance will depend on the multi-layered structure of the earth.

For inductive interference, gradient control wires provide additional grounding for the pipeline and decrease the induced pipe potential rise. At the same time, they raise local ground potentials, thus sharply reducing touch potentials and coating stress voltages.

For conductive interference, gradient control wires dampen the soil potential rise close to the pipe while raising pipe potentials, thus providing reduced touch voltages and decreasing coating stress voltages.

Life expectancy of Plattline in this application would be quite long and would generally be determined by Plattline as a projected cathodic protection system. The most common sizes of Plattline for AC mitigation are plus and standard.

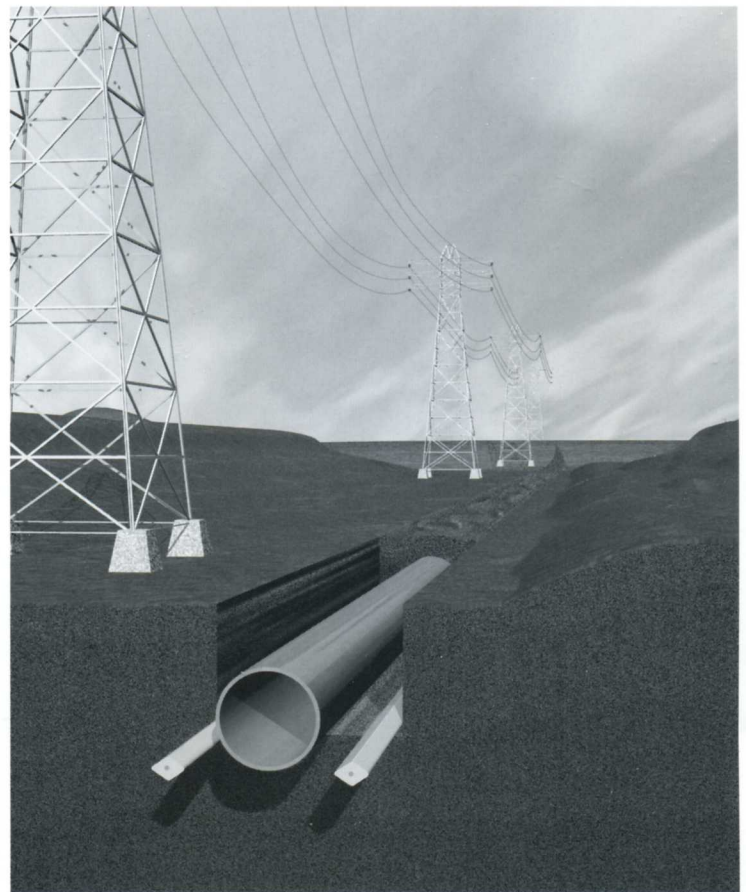

Figure 1 – Plattline used for AC mitigation

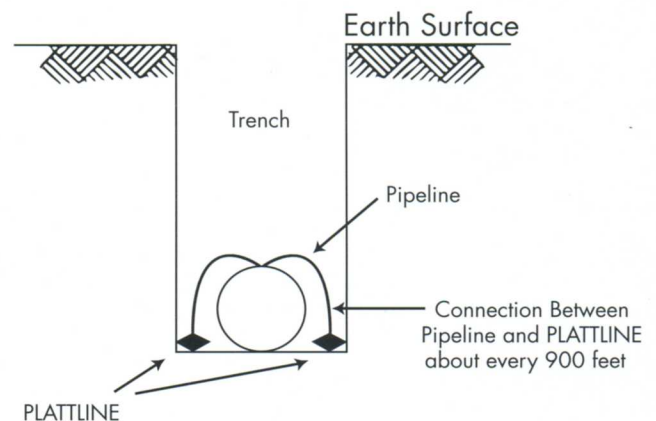

Figure 2 - Plattline connections to the pipe

FOR AC MITIGATION

Plattline can provide a significant means to mitigate potential gradients along the length of a pipeline. Importance must also be placed on reducing the potentials at valve sites, metering stations, pig launchers and receivers and other accessible installations for worker safety.

Gradient control grids or grounding mats raise local ground potentials in the same way gradient control wires do. These grounding mats can be made in several forms. Spiral and rectangular designs are generally standard for grounding mats. These are shown in Figures 3, 4 and 5. The most common size of Plattline for grounding mats is standard.

Reference should be made to NACE Standard RP0177 (Latest Revision) - Recommended Practice on Mitigation of Alternating Current & Lightning Effects on Metallic Structure and Corrosion Control Systems. Also, ANSI/IEEE Standard 80 specifies safety design criteria for determining maximum acceptable touch and step voltages during fault conditions.

Finally, during fault conditions on the power line, the system must ensure that pipeline coating stress voltages remain within acceptable limits to prevent coating damage and damage to the pipeline steel. Coating damage can occur in the range of 1000 - 2000 volts for bitumen based coatings and in the range of 3000 - 5000 volts for polyethylene or fusion-bonded epoxy coated pipelines.

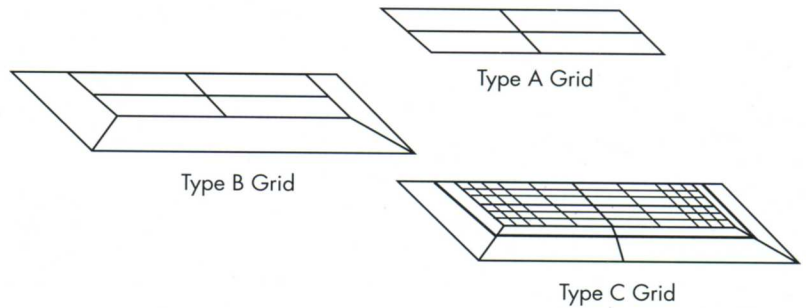

Figure 3 - Rectangular control mat examples

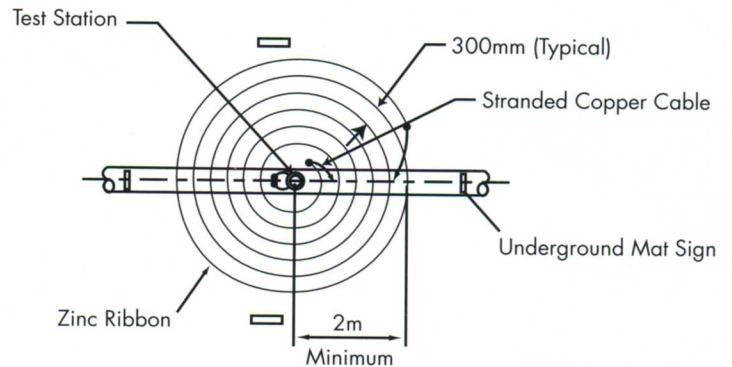

Figure 4 - Spiral gradient control mat - top view

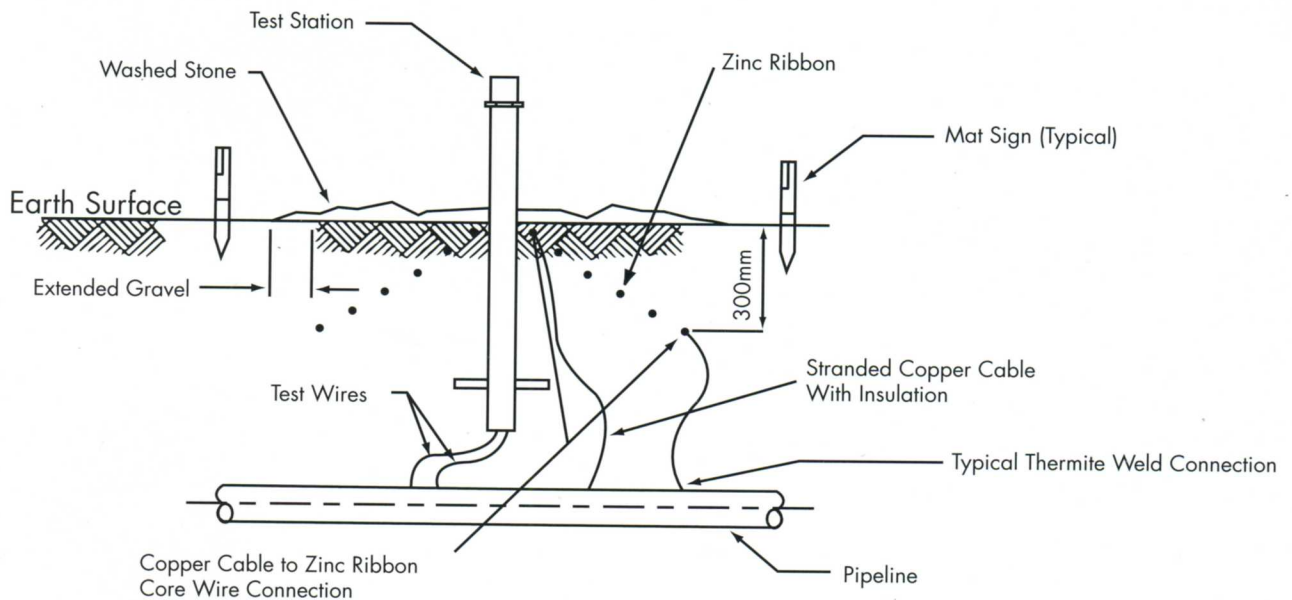





Figure 5 - Spiral gradient control mat - side view



PLATTLINE™ ZINC RIBBON ANODES

Product Data Sheet

Plattline™ zinc ribbon anodes are used in a variety of applications. They are used for cathodic protection on buried pipelines, for A.C. mitigation on pipelines, for sacrificial cathodic protection of secondary bottoms on above-ground storage tanks, for A.C. mitigation grounding mats and for other corrosion protection applications.

Specification Chart				
Product Size	Super	Plus	Standard	Small
Cross Section: Inches Millimeters	1" x 1-1/4" 25.4 x 31.75	5/8" x 7/8" 15.88 x 22.22	1/2" x 9/16" 12.7 x 14.28	11/32" x 13/32" 8.73 x 10.32
Weight/Foot, Pounds Weight/Kg., Meters	2.4 3.570	1.2 1.785	0.6 .8925	0.25 .372
Diameter of wire core Inches Millimeters	0.185 4.70	0.135 3.43	0.130 3.30	0.115 2.92
Standard Coil Length Feet Meters	100 ⁺¹⁰ ₋₀ 30.5 ⁺³ ₋₀	200 ⁺²⁰ ₋₀ 61 ^{+6.1} ₋₀	500 ⁺³⁰ ₋₀ 152 ⁺⁹ ₋₀	1000 ⁺⁵⁰ ₋₀ 305 ⁺¹⁵ ₋₀
Standard Coil I.D. Inches Centimeters	36 91.44	36 91.44	12 30.5	12 30.5
Packaging	Steel-banded random-wound open coils	Steel-banded random-wound open coils	Wood Reels	Wood Reels

- All dimensions and weights are nominal.
- Galvanized Steel
- "Arctic" standard size has nominal core diameter of .163 inches (4.140 mm.)
- Longer coil lengths are available on special order. Standard size also available in reels of 1000 ft and 3600 ft.



Plattline I is an alloyed zinc product and is generally used in seawater or brackish water systems. It meets the chemical requirement of MIL-A-18001K and ASTM B418-95a Type I.

Plattline II is a high purity product and generally used in underground and fresh water systems. It meets the chemical requirements of ASTM B418-95a Type II.

STUART STEEL PROTECTION CORP.
 BOX 476
 SOUTH BOUND BROOK, NJ 08880
 PHONE (732) 469-5544
 FAX (732) 469-9270
 E-mail: sspcmail@worldnet.att.net
 Website: www.stuartsteel.com

The Platt Brothers & Co.
 T 800-752-8276

Merbury, CT 06721
 @snet.net

This document its contents and related information are subject to change without notice. The user's responsibility is at the user's independent discretion. In connection therewith, Platt Bros. & Co. shall have no liability for any loss, damage, injury, practicability, freedom of patent or other infringement, or conformance to codes, standards or regulations. The foregoing may be waived or modified only in writing by an authorized officer of the Platt Bros. & Co.